

Luminance Meter

Code: 86332
User Manual V1.03

Please read this manual carefully before using and reserve it for reference.

I. Product introduction

The instrument is a multifunctional luminance meter equipped with a spectral sensor. It is designed to measure luminance, flicker frequency, color rendering index (CRI), and correlated color temperature (CCT) of display screens, backlight panels, lighting fixtures, and similar applications. Additionally, the instrument can display the spectral distribution curve, which helps in identifying the type of backlight source.

Standards for the product

GB 50034-2024 Standard for lighting design of buildings

GB 40070-2021 Hygienic requirements of study products for myopia prevention and control in children and adolescents

GB/T 9473-2022 Performance requirements for table lamps for paper task

GB/T 39388-2020 Characterization of the performance of illuminance meters and luminance meters

JJG 211-2021 Verification Regulation of Luminance Meters

T_ZZB 2793-2022 Spectral radiance meter

II. Technical Parameters

Parameter Name	Parameter Value
Luminance Wavelength Range	400nm ~ 700nm
Luminance Wavelength Interval	10nm
Luminance Measurement Distance	≤1m
Luminance Measurement Range	1 ~1,000,000cd/m ²
Luminance Resolution	0.01cd/m ²
Luminance Measurement Accuracy	≤ ± (5%H+2cd/m ²) (H is the standard value, calibrated with the CIE standard illuminant A)
Luminance Unit Options	cd/m ² (default), fL
CCT Measurement Range	1,000 ~ 100,000K
CCT Measurement Accuracy	±5% (Calibrated with the CIE standard illuminant A)
CRI Measurement Range	0 ~ 100
CRI Measurement Accuracy	±2 (Calibrated with the CIE standard illuminant A)
Flicker Frequency Measurement Range	10 ~ 500 Hz
Flicker Frequency Measurement Distance	≤0.1m

Flicker Frequency Measurement Accuracy	±5%
Test Aperture Diameter	Φ10mm/20mm
Host Size	147.2mm * 72mm * 28mm
Probe Size	Diameter 40mm*Thickness 76mm
Weight	About 370g (including batteries)
Display	240*160 Dot Matrix LCD
Power Supply	2 AA Alkaline Batteries
Operating Temperature Range	0°C~50°C, 0~85%RH(no condensation)
Storage Temperature Range	-10°C~60°C, 0~85%RH(no condensation)
Supply Voltage	DC3V
Operating Current	20mA
Operating Power Consumption	60mW

III. Spectral response curve

Adopting the spectral sensor design, the luminance value is obtained by integral of the $V(\lambda)$ function with the measured spectrum, ensuring that the spectral response curve of the instrument is in perfect agreement with $V(\lambda)$.

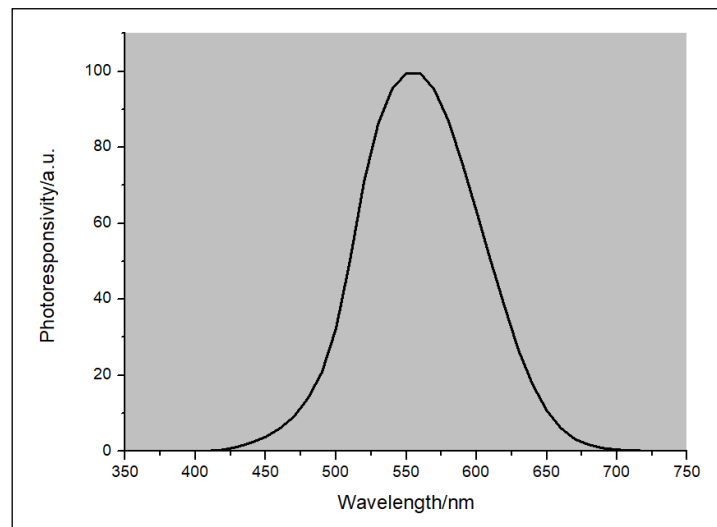





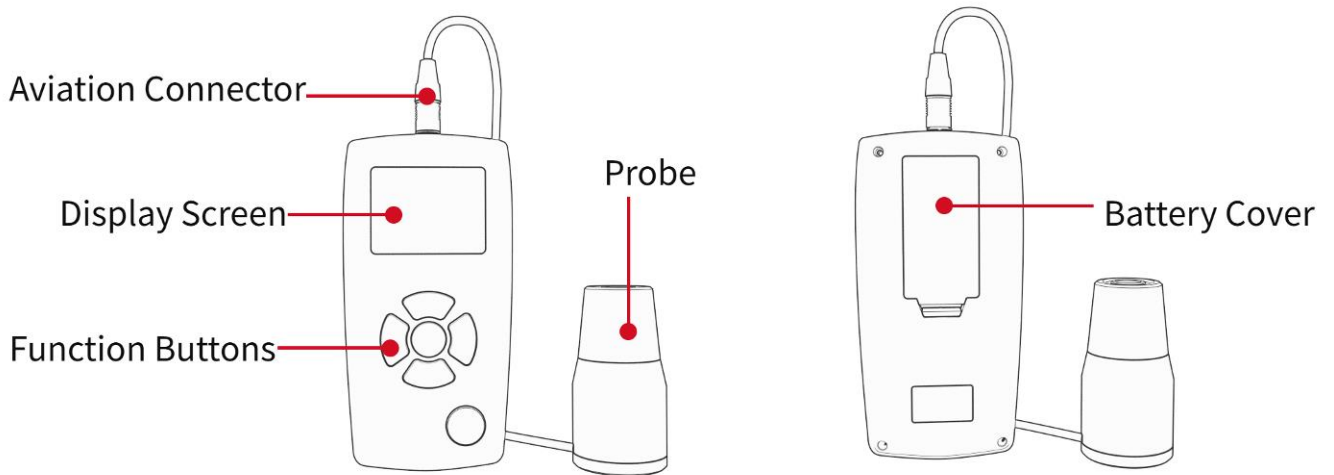

IV. Operations

1. Instrument structure



2. Parameter settings

In the off state, long press the  button 3s to enter the system setting mode. In the setting mode, you can select language, aperture, unit, auto off, factory reset, etc. The     buttons are for selection and the  button is for confirmation.

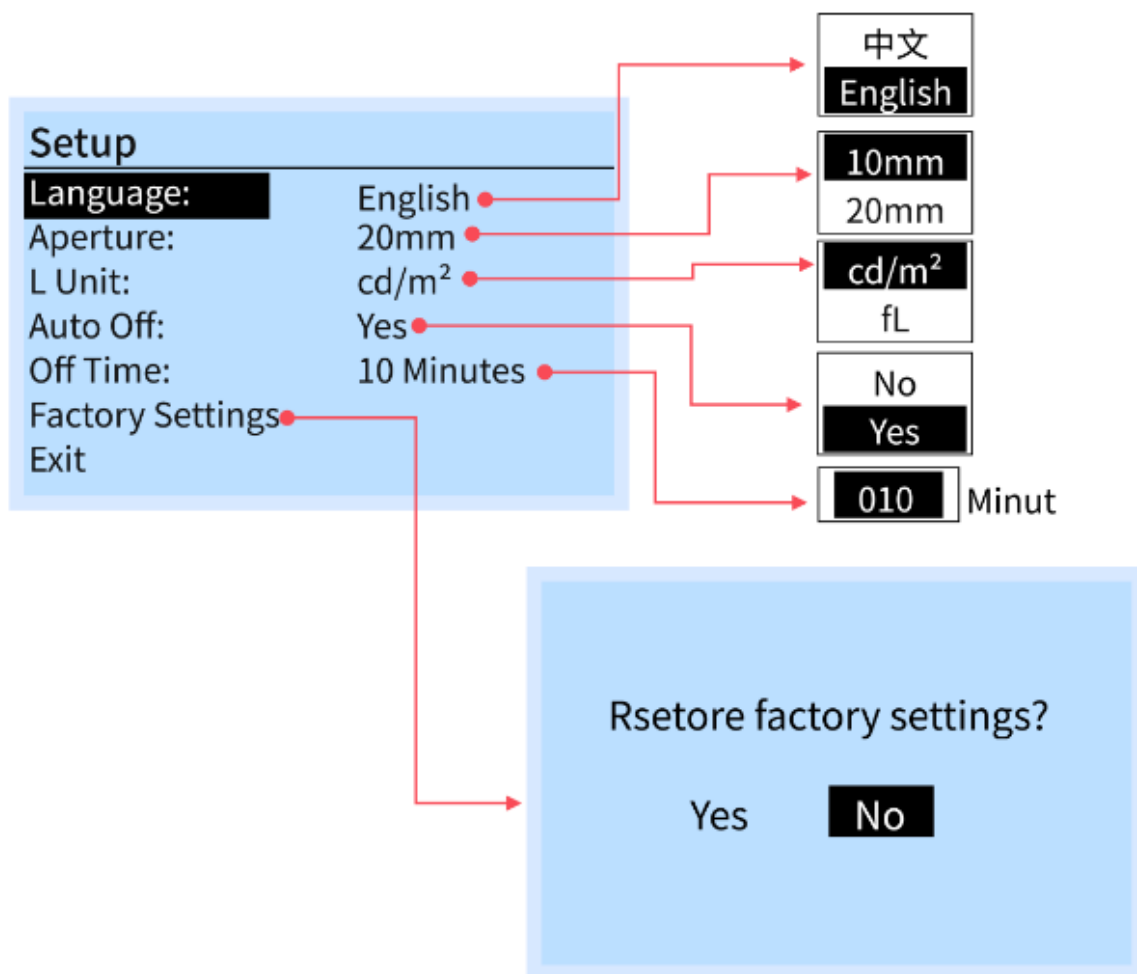

3. Measurement

After the instrument is turned on, enter the parameter interface of the measurement mode. Short press the



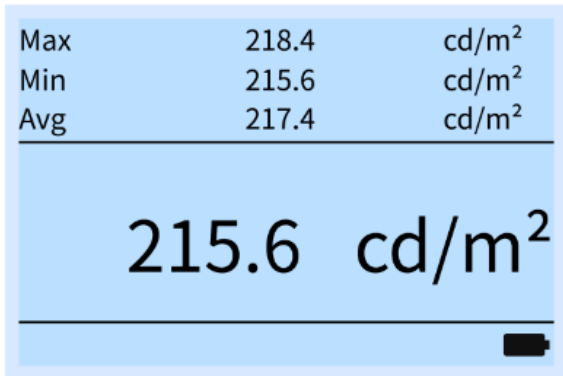

button to switch to the spectrum curve interface.



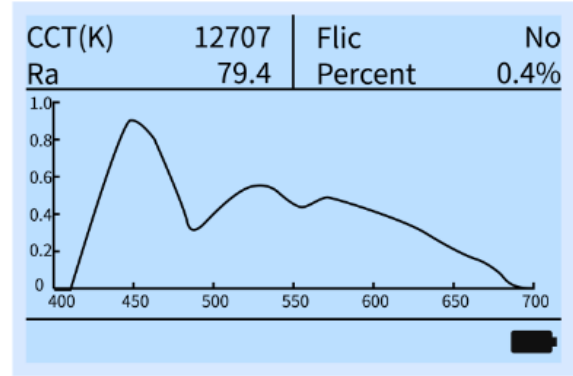

Luminance interface



Spectral curve interface

Short press the  button to start a new measurement without saving data. Short press the  button to lock and save the current data, and short press the  button again to start a new measurement.

4. View history records

Short press  or , enter the record data query mode. The instrument will display the latest recorded data No.1 (up to 9 recorded data are stored in the instrument, and the oldest recorded data will be deleted automatically when exceed 9 recorded data). Short press  and follow the prompts to delete the history data.

5. Probe light tube replacement

To measure the luminance of a small light source, please replace the light tube. Unscrew the probe light tube clockwise and replace it with a ϕ 10mm light tube. After replacing it, select the corresponding light tube size in the setting menu.

6. PC Software Operation

Connect the device to a computer via USB to use the dedicated PC software for illuminance and luminance meters. The software supports reading measurement records, viewing spectral data, exporting data to Excel, and other functions.

The screenshot shows the SpectralLuminanceMeter V1.0 software interface. At the top, there are buttons for 'English' and '中文'. Below that, a 'Device information' section displays 'SN: 332000212' and 'Firmware Version: 2.00'. To the right of this section are buttons for 'Read Records', 'Clear Data', 'Export Excel', and 'Spectral Data'. The main part of the interface is a table with 8 rows of data. Each row has columns for Luminance (cd/m²), MAX (cd/m²), MIN (cd/m²), AVG (cd/m²), CCT (K), Flic Freq (Hz), Percent (%), Ra, and Operation. The 'Operation' column contains a 'Delete' button for each row.

	Luminance (cd/m²)	MAX (cd/m²)	MIN (cd/m²)	AVG (cd/m²)	CCT (K)	Flic Freq (Hz)	Percent (%)	Ra	Operation
1	26.64	26.64	26.64	26.64	5581	No	2.3	84.8	Delete
2	25.65	463.18	4.08	34.88	5349	No	2.5	83.6	Delete
3	18.61	28.79	11.95	19.78	3809	----	----	73.8	Delete
4	26.14	32.44	0.00	19.64	5301	26	1.9	83.8	Delete
5	126.27	456.74	3.22	44.04	8717	----	----	88.3	Delete
6	22.01	22.01	4.73	13.37	3437	----	----	68.4	Delete
7	158.08	158.38	2.25	130.66	8293	60	0.6	85.9	Delete
8	6218.97	6235.60	6218.97	6227.79	4976	No	0.3	91.2	Delete

V. Measurement and precautions

1. When not in use, please long press the  button to power off.
2. Avoid contacting with corrosive materials and keep away from high humidity.
3. The recommended period of calibration is one year.
4. When not in use for a long time, be sure to store the instrument in a low humidity environment.
5. When the instrument displays “Low Battery”, please replace the battery.

VI. Measurement Parameters and China National Standard Explanation

1. *IEEE Std 1789-2015*, P12, 4.1, *GBT 9473-2017 Performance requirements for table lamps for paper task*, P2, 3.6, P4, 5.5.2.

Percent flicker, also known as flicker percentage or modulation depth, is the ratio of the difference between the maximum and minimum values of light output over one cycle to the sum of the maximum and minimum values of light output. The definition of flicker-free LED desk lamps is as follows:

Flicker Frequency/Hz	$f \leq 10$	$10 < f \leq 90$	$90 < f \leq 3125$	$f > 3125$
Flicker Percentage Limits/%	0.1	$f * 0.01$	$f * 0.08 / 2.5$	No Limits

Flicker frequency refers to the number of cycles a light source goes through from bright to dim and back to bright within a certain period.

The domestic mains frequency is 50 Hz, corresponding to a flicker frequency of 100Hz. The flicker-free limit is calculated as $100 * 0.08 / 2.5 = 3.2\%$. If the flicker percentage is below this limit, the flicker frequency is displayed as "No flicker".

2. *GB 50034-2013 Standard for lighting design of buildings*, P5、 6.

Color Rendering Index (Ra): The color rendering index (CRI) is a measure of the color rendering of a light source, which indicates the extent to which the color of the object under the light source being measured and the color of the object under the reference standard light source are in accordance with each other. The general CRI, commonly referred to as Ra, is the average value of the CRI of the first 1 to 8 standard color samples specified by the International Commission on Illumination (CIE).

Correlated Color Temperature (CCT): If the chromaticity of a light source does not lie on the blackbody trajectory but is closest to the chromaticity of a blackbody at a particular temperature, then the absolute temperature of that blackbody is the correlated color temperature of the light source, abbreviated as CCT.

3. *GB 40070-2021 Hygienic requirements of study products for myopia prevention and control in children and adolescents*, P5, 10.

Hygienic requirements for lighting fixtures in ordinary classrooms: The correlated color temperature (CCT) should be no less than 3300K and no more than 5300K. The general color rendering index (Ra) should be no less than 80.

4. *GBT 9473-2017 Performance requirements for table lamps for paper task*, P4, 5.4.

The general color rendering index (Ra) should not be less than 80. The percent flicker should not exceed the limit corresponding to the "no significant impact" level.

5. *GB 40070-2021 Hygienic requirements of study products for myopia prevention and control in children and adolescents*, P6, 11.6.

Lamps should be equipped with proper shading and must not produce excessive glare. For lamps with a light outlet height of less than 750 mm in the normal working position, the surface luminance of all visible luminous components, as observed from a seated position, should not exceed 2000 cd/m².

VII. Packing list

No.	Description	Quantity	Unit
1	Luminance Meter Host	1	pcs
2	Luminance Meter Probe (Standard ϕ 20mm light tube)	1	pcs
3	ϕ 10mm light tube	1	pcs

4	User Manual	1	pcs
5	Calibration Report	1	pcs

VIII. Service

1. The meter has one-year warranty. If the instrument works abnormally, please send the whole instrument to our company for maintenance
2. Provide users with spare parts and lifelong maintenance services
3. Provide the users with the meter calibration service
4. Free technical support for long term